

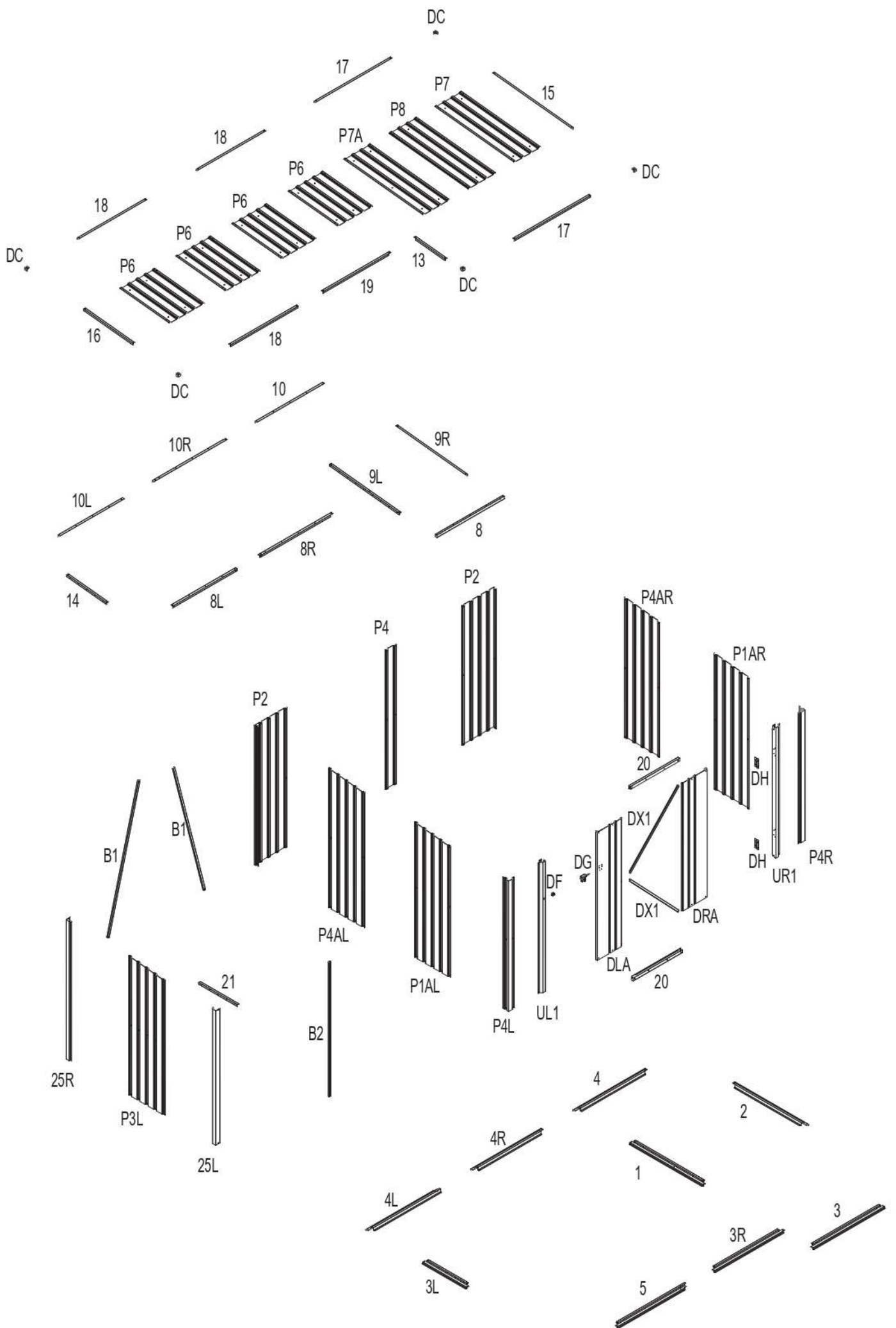

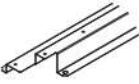



































































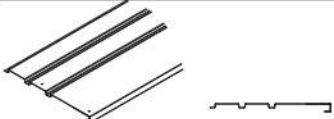
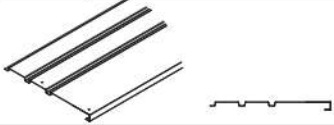
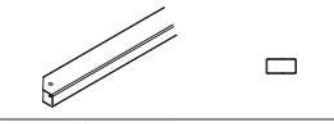

ARPOL TYP 2 LNSW-02









1			1
2			1
3			1
3L			1
3R			1
4			1
4L			1
4R			1
5			1
8			1
8L			1
8R			1
9L			1
9R			1
10			1

10L			1
10R			1
13			1
14			1
15			1
16			1
17			2
18			3
19			1
20			2
21			1
25L			1
25R			1
B1			2
B2			1

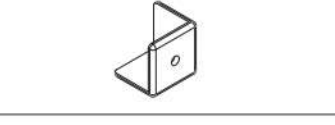
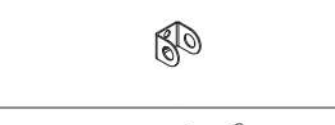
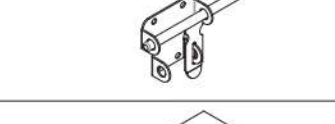
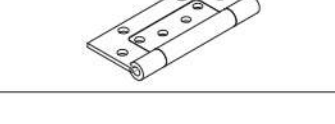
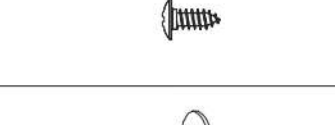
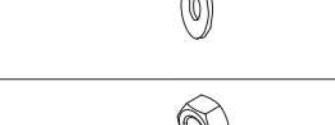
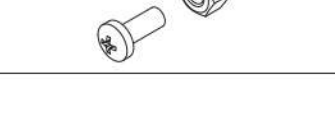
DLA		1
DRA		1
DX1		2
P1AL		1
P1AR		1
P2		2
P3L		1
P4		1
P4AL		1
P4AR		1
P4L		1
P4R		1
P6		4
P7		1
P7A		1

P8		1
UL1		1
UR1		1
DC		5
DF		1
DG		1
DH		2
F1		160
S2		150
F2		260
F3		20

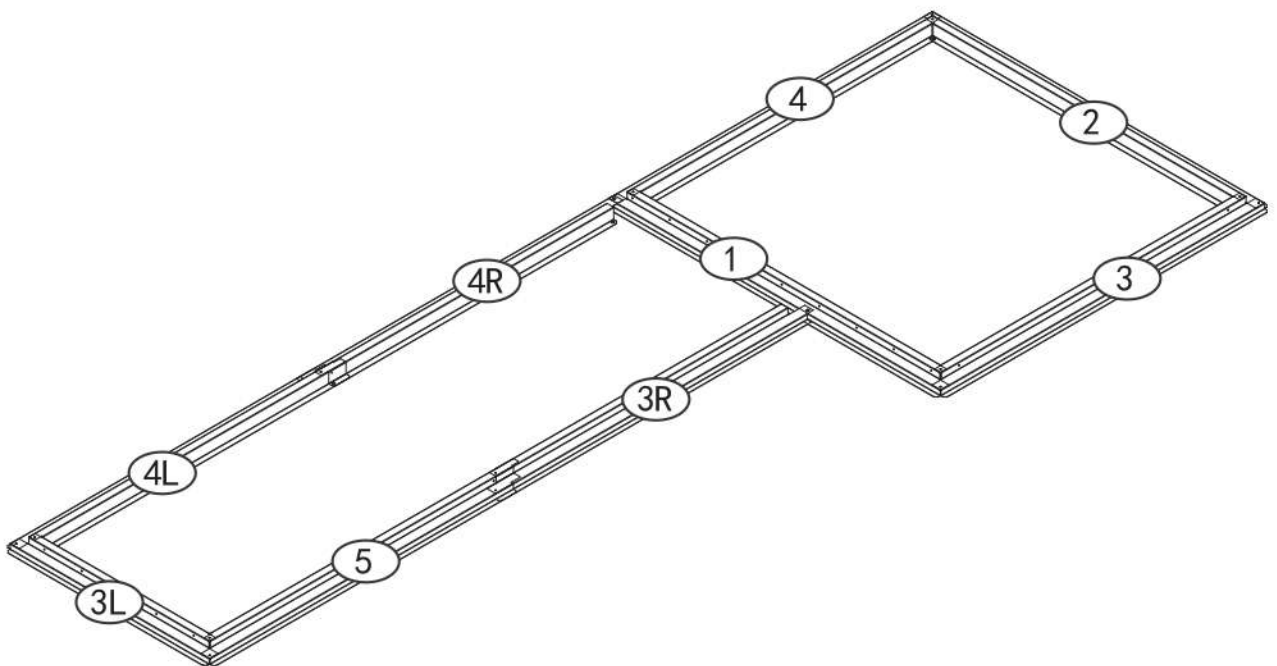
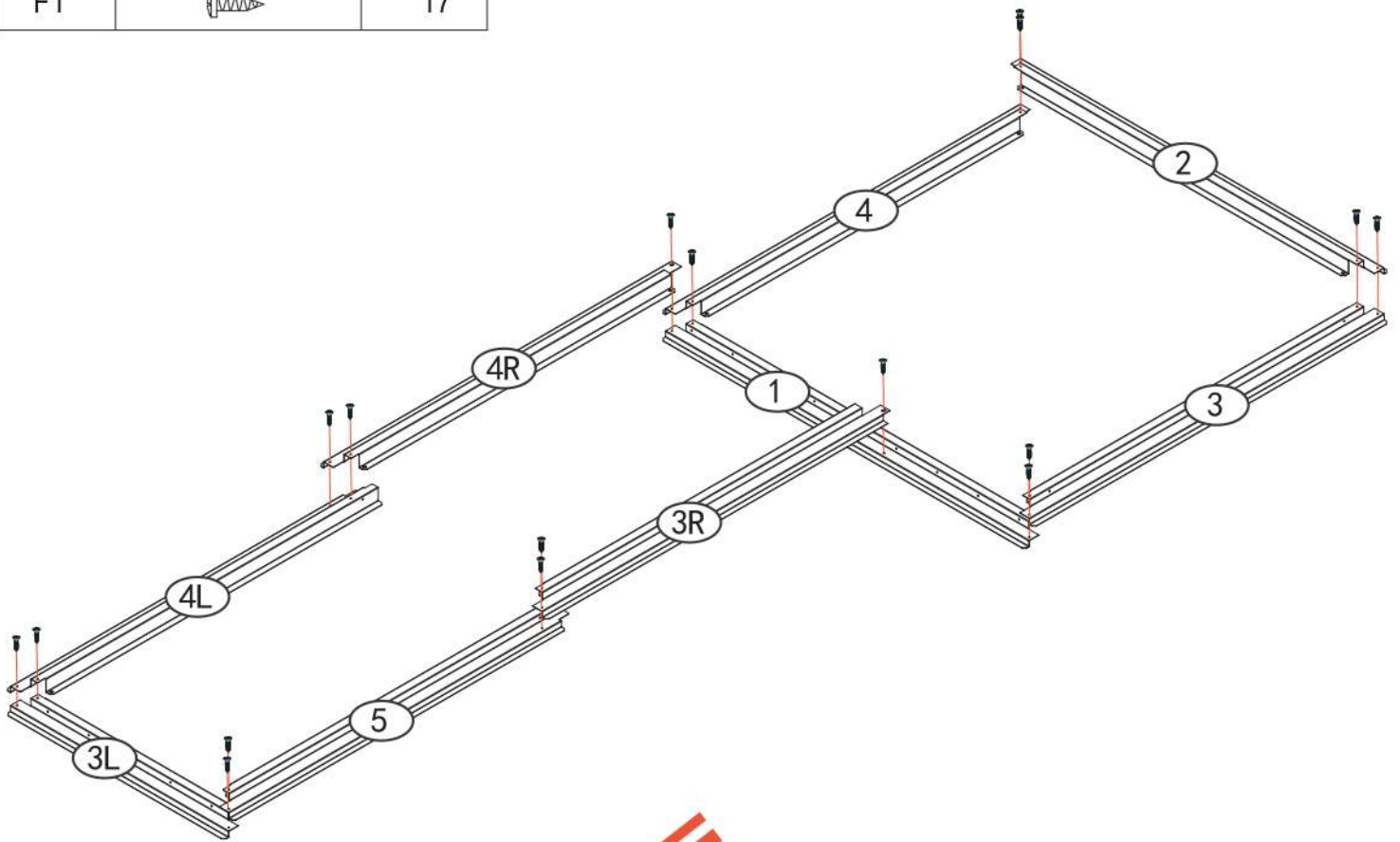



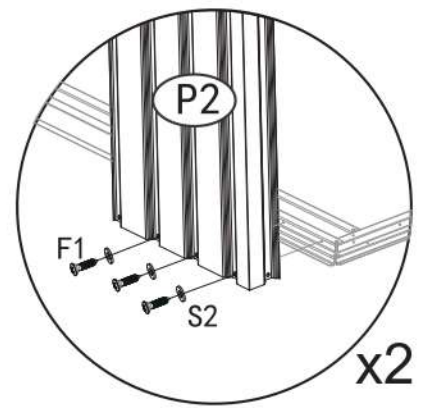



Osnovni dio neće biti potpuno prikazan u kasnijoj fazi

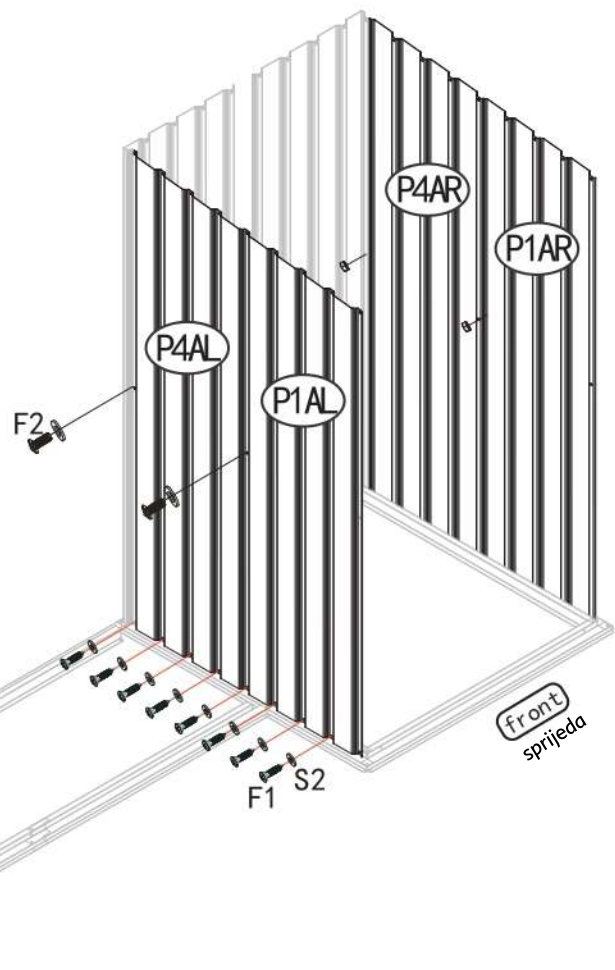





P2		4
F1		6
S2		6

P1AL		1
P1AR		1
P4AL		1
P4AR		1
F1		16
F2		4
S2		20

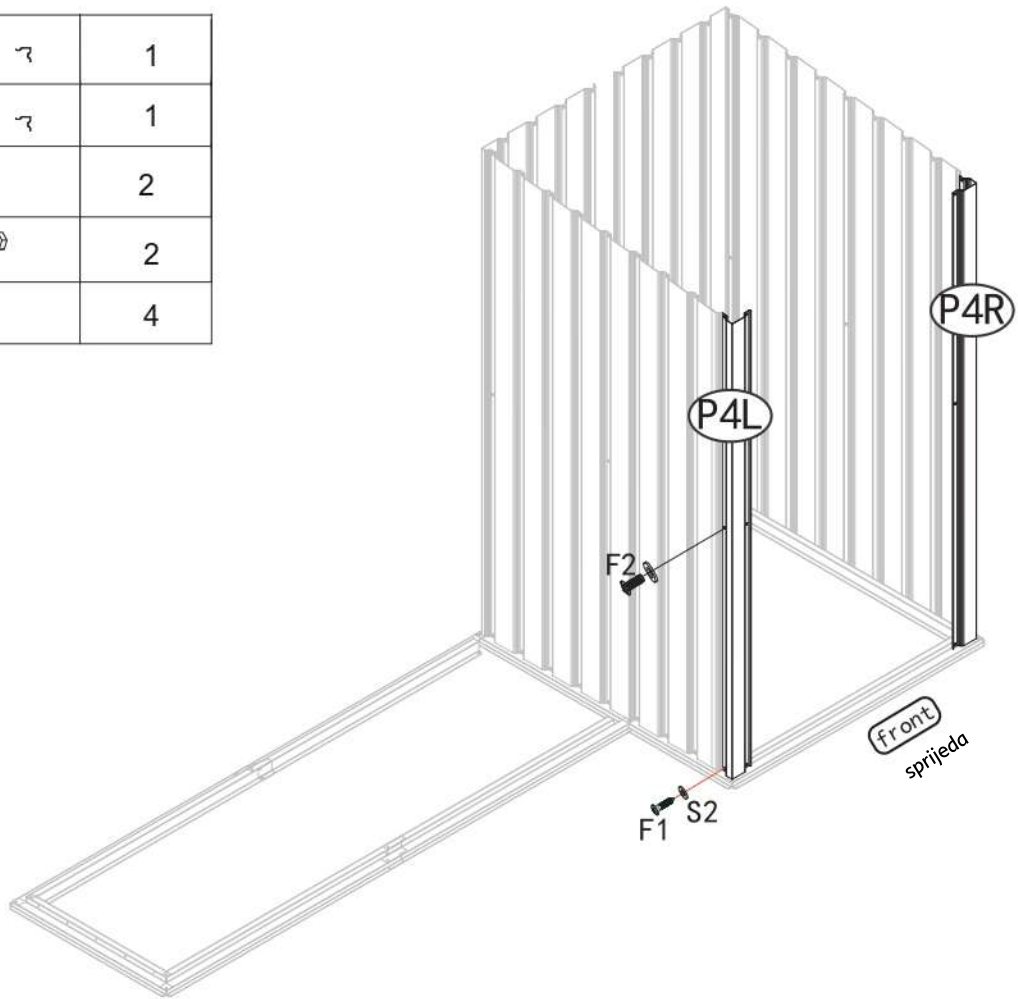





P4L		~	1
P4R		~	1
F1			2
F2			2
S2			4

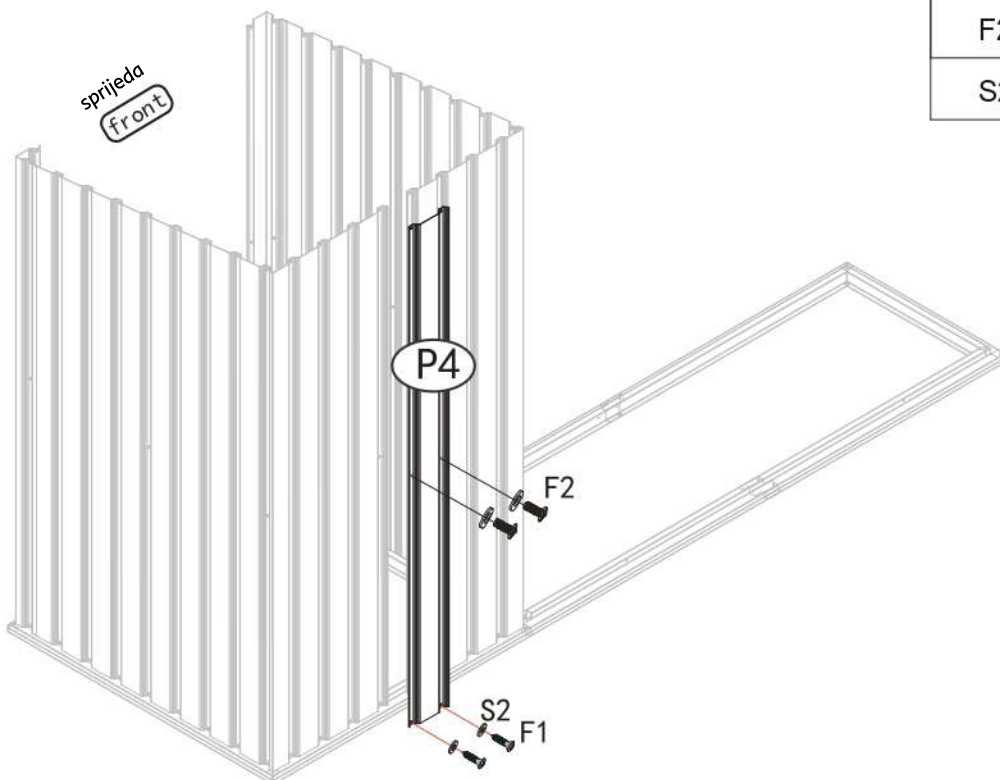





P4		~	1
F1			2
F2			2
S2			4

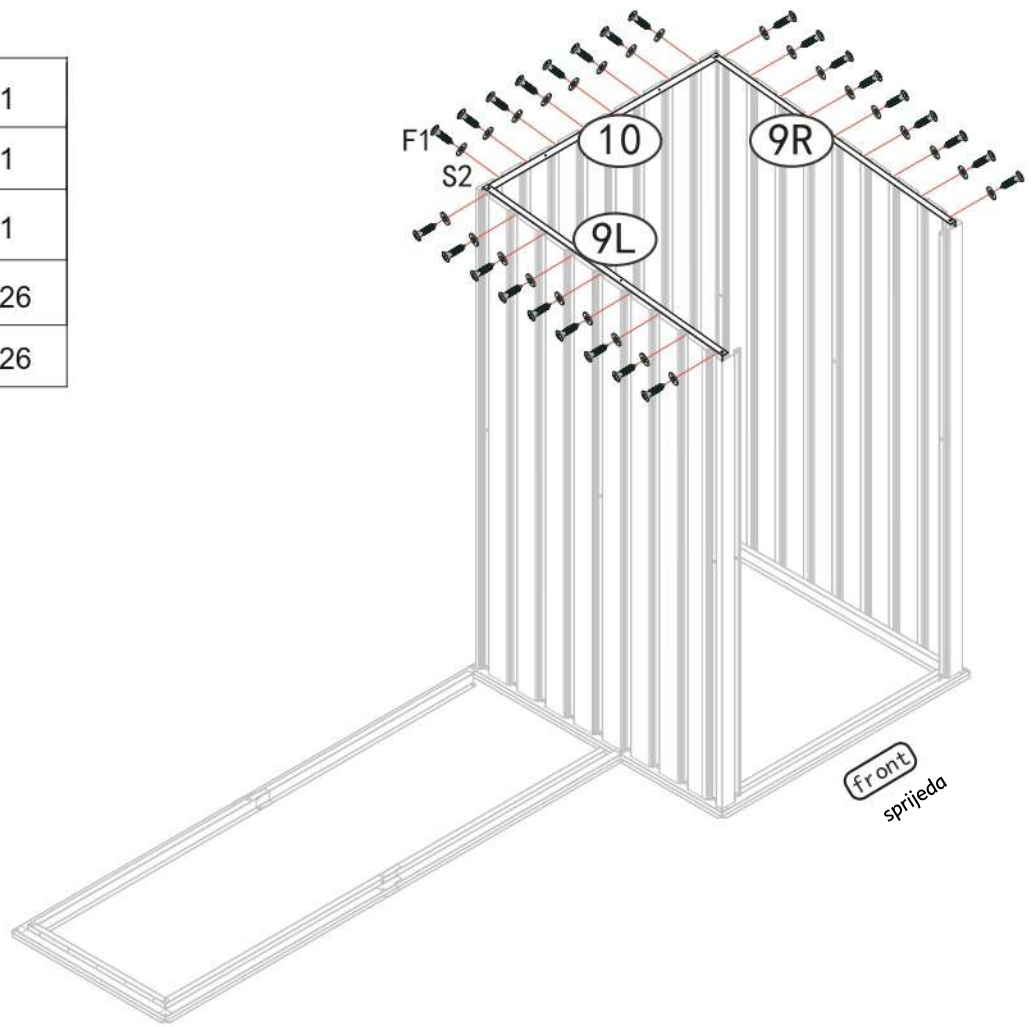





9L		┌	1
9R		┐	1
10		┌	1
F1			26
S2			26

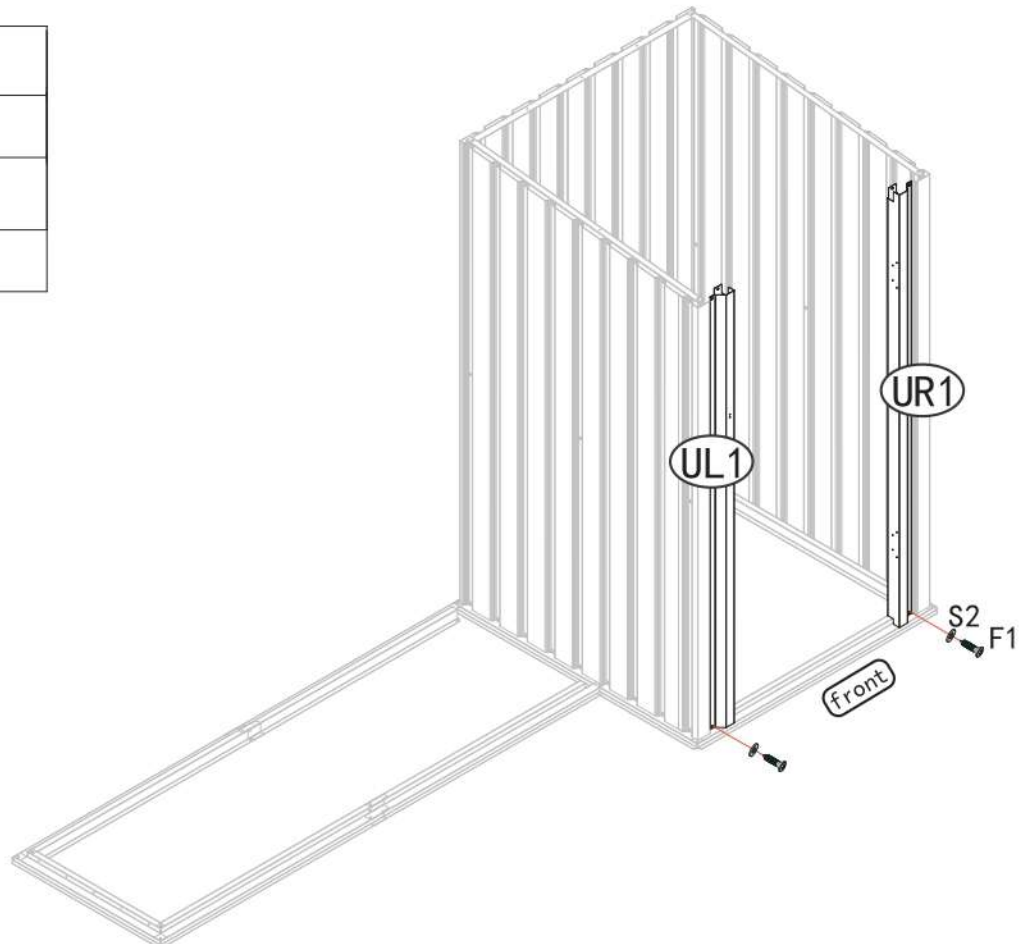







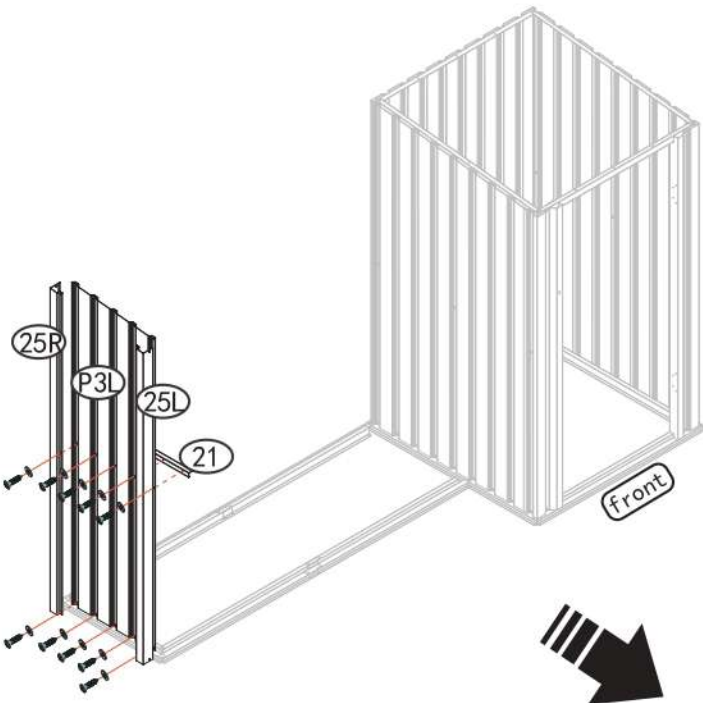
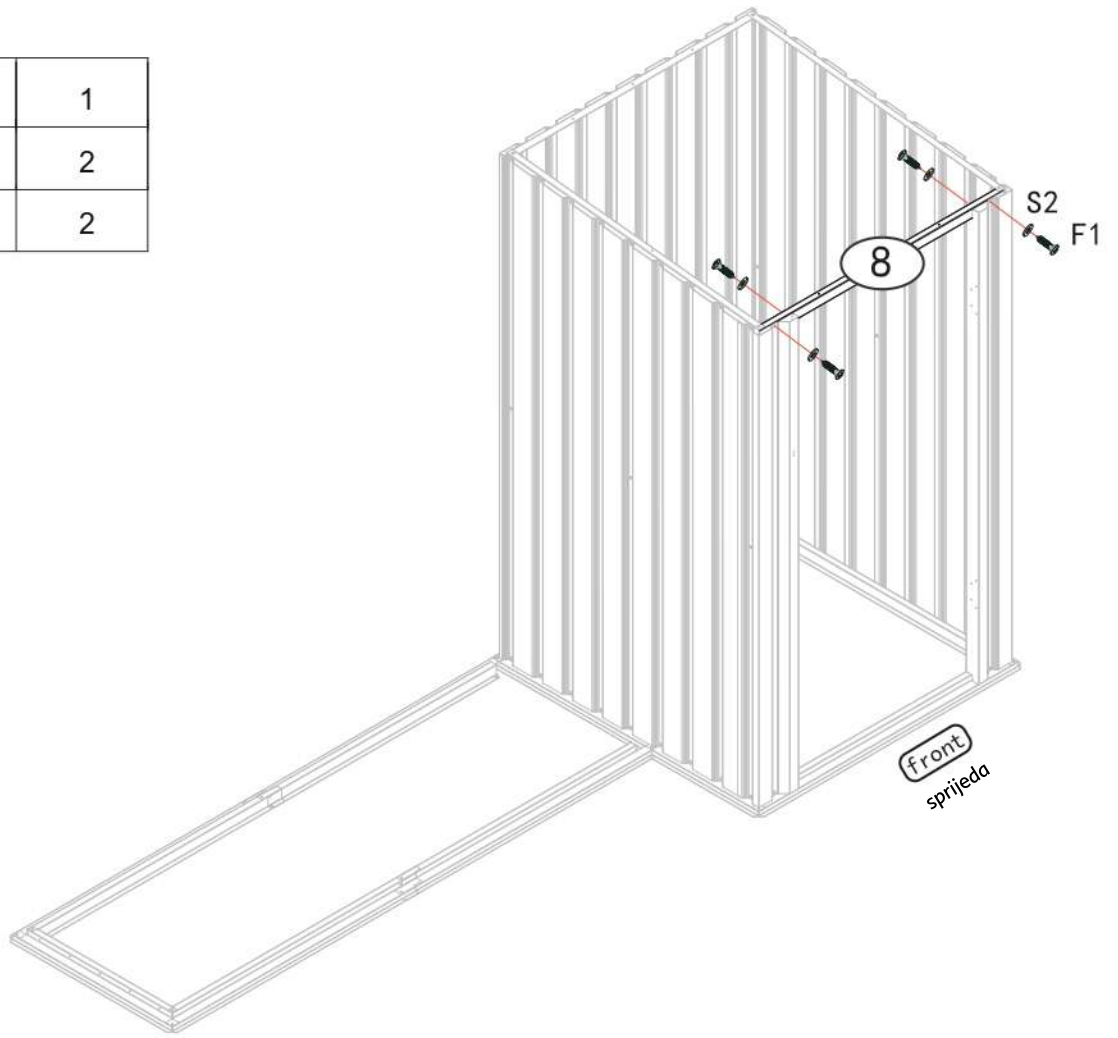

UL1		┐	1
UR1		┌	1
F1			2
S2			2



8			1
F1			2
S2			2



25L			1
25R			1
P3L			1
21			1
F1			12
S2			12

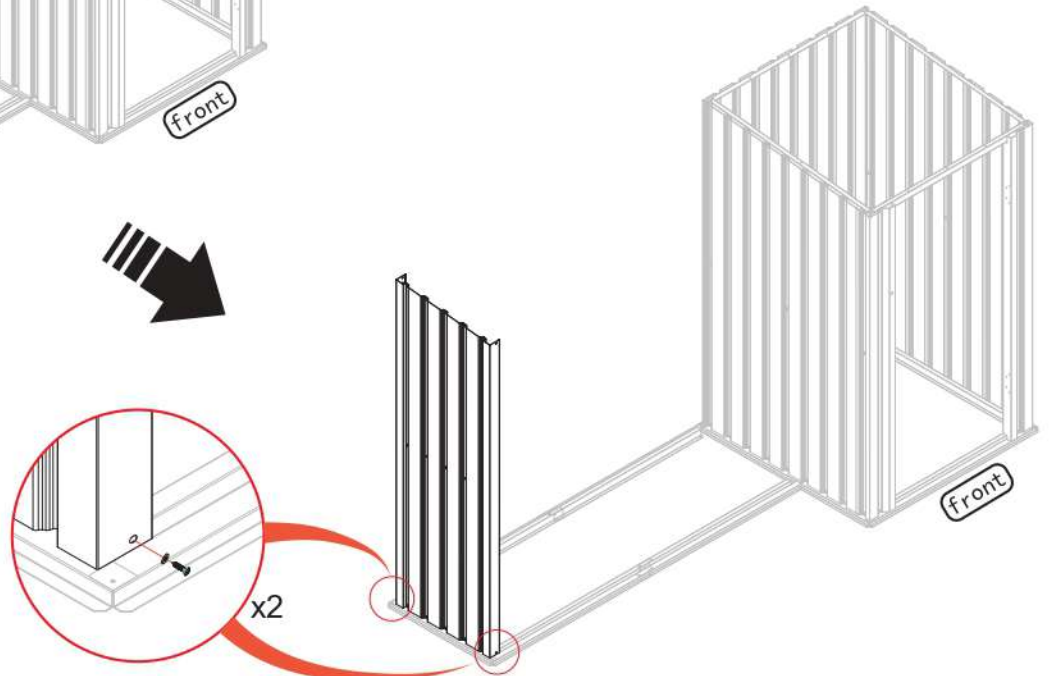

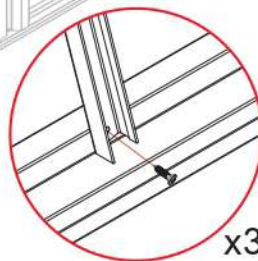
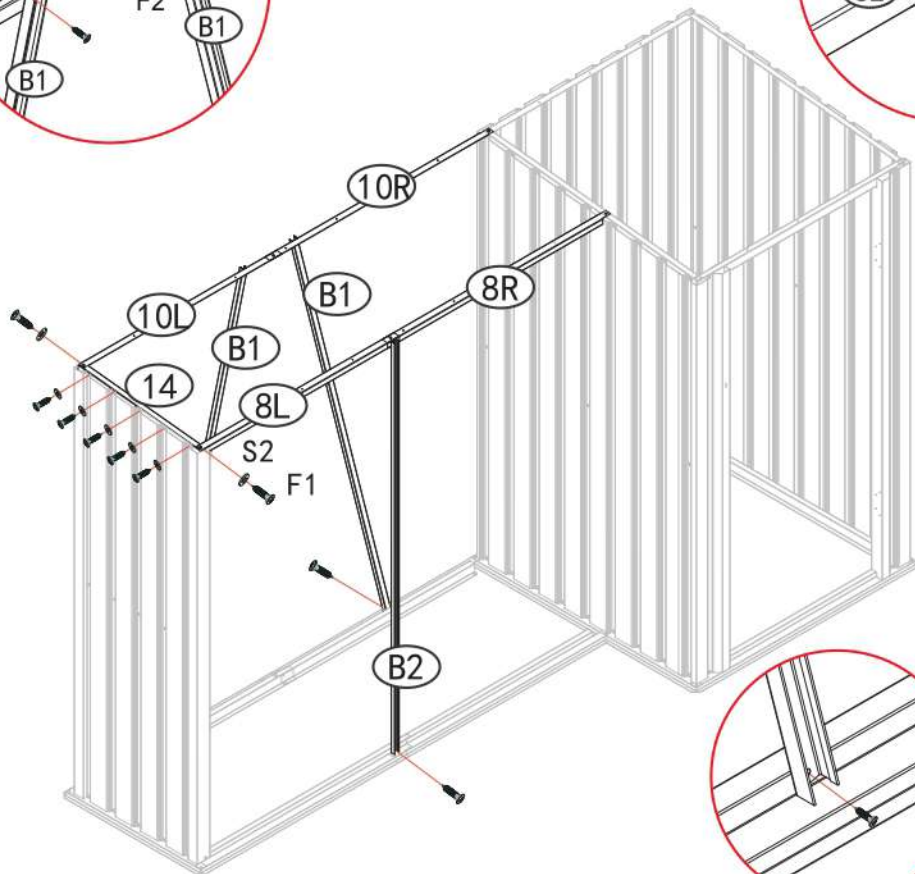
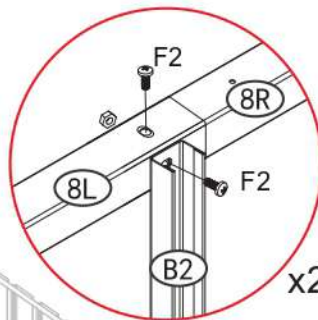
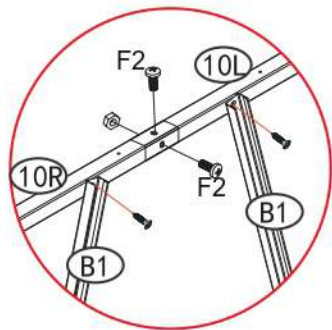

B1		□	2
B2		□	1
8L		┌	1
8R		┐	1
10L		┌	1
10R		┐	1
14		┌	1
F1			12
F2			4
S2			7

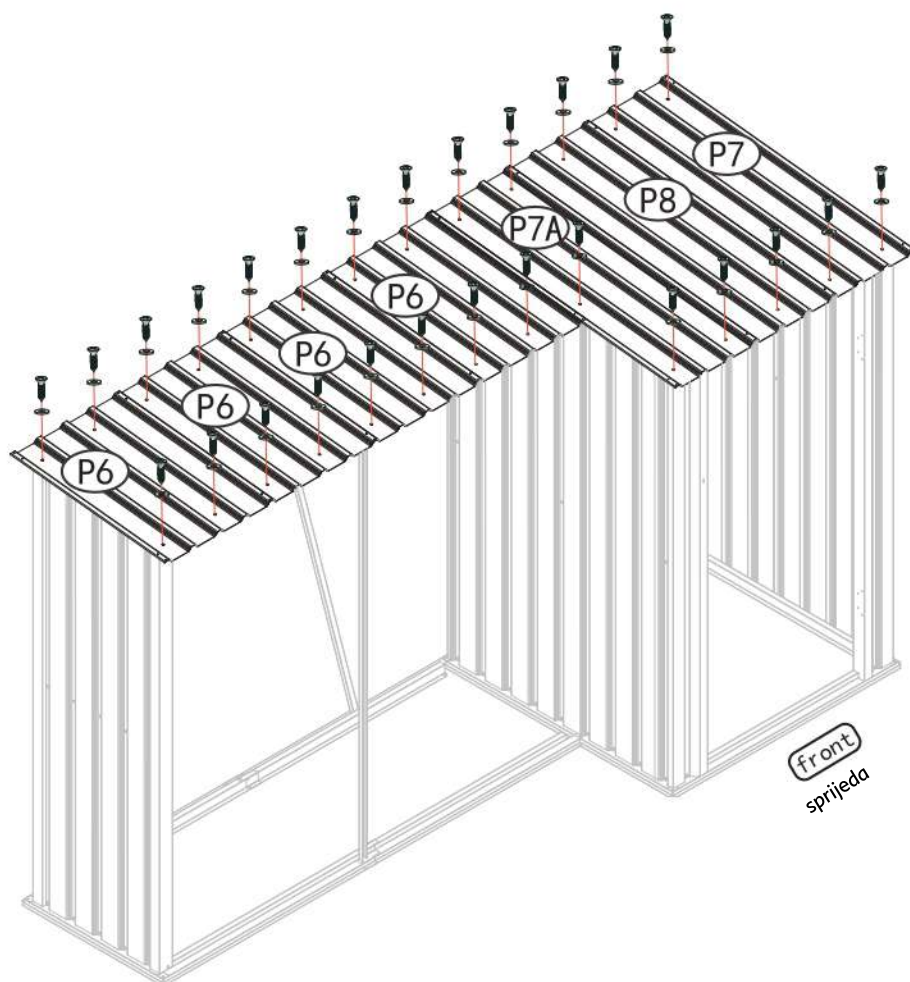

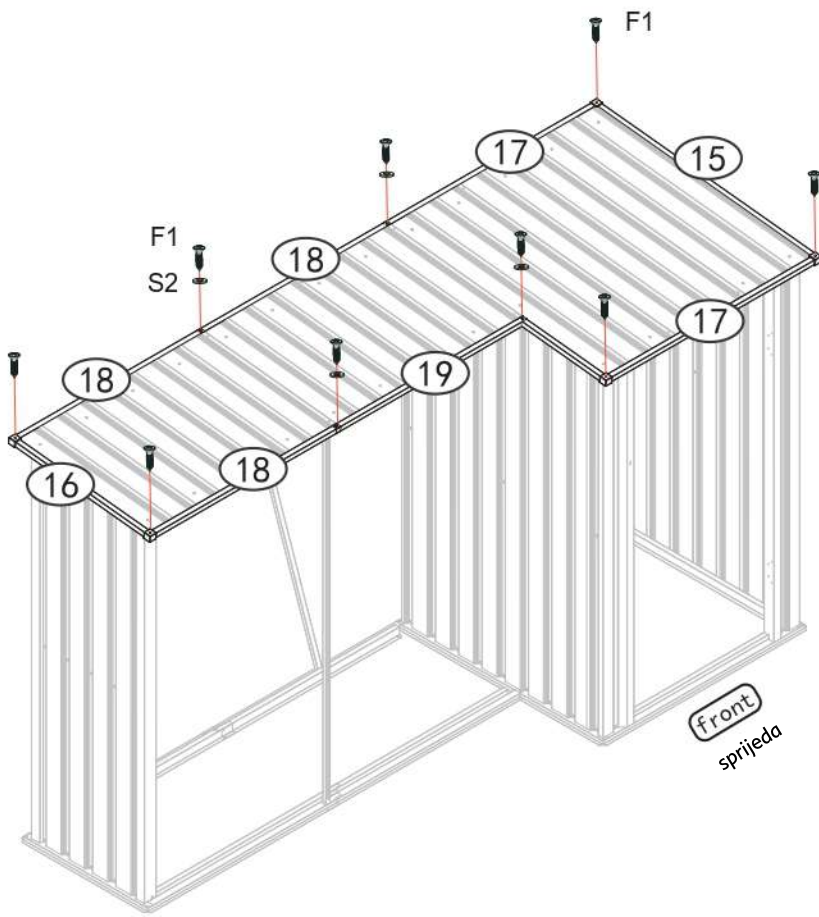

P6			4
P7			1
P7A			1
P8			1
F1			14
S2			14



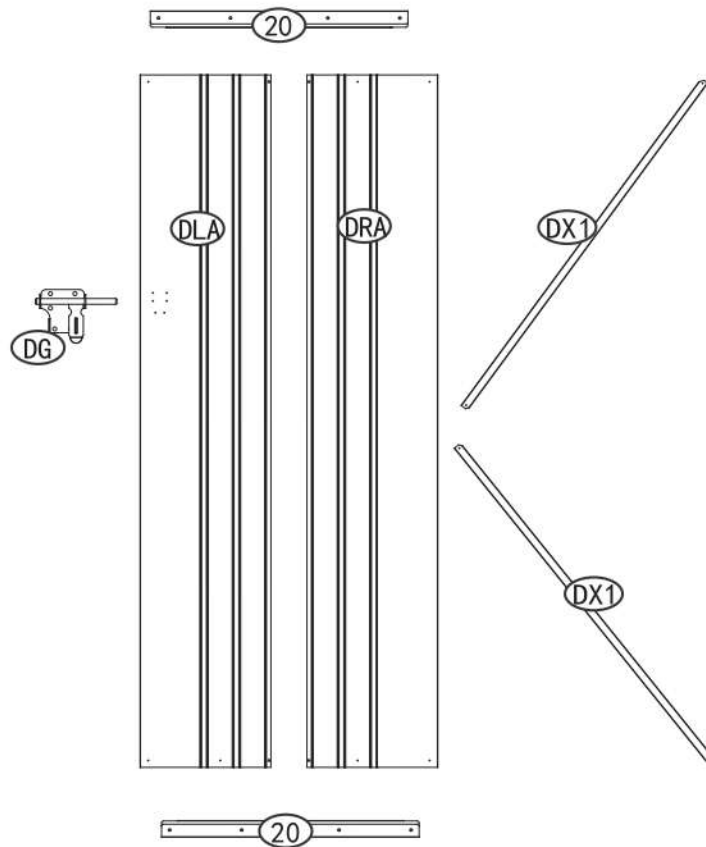

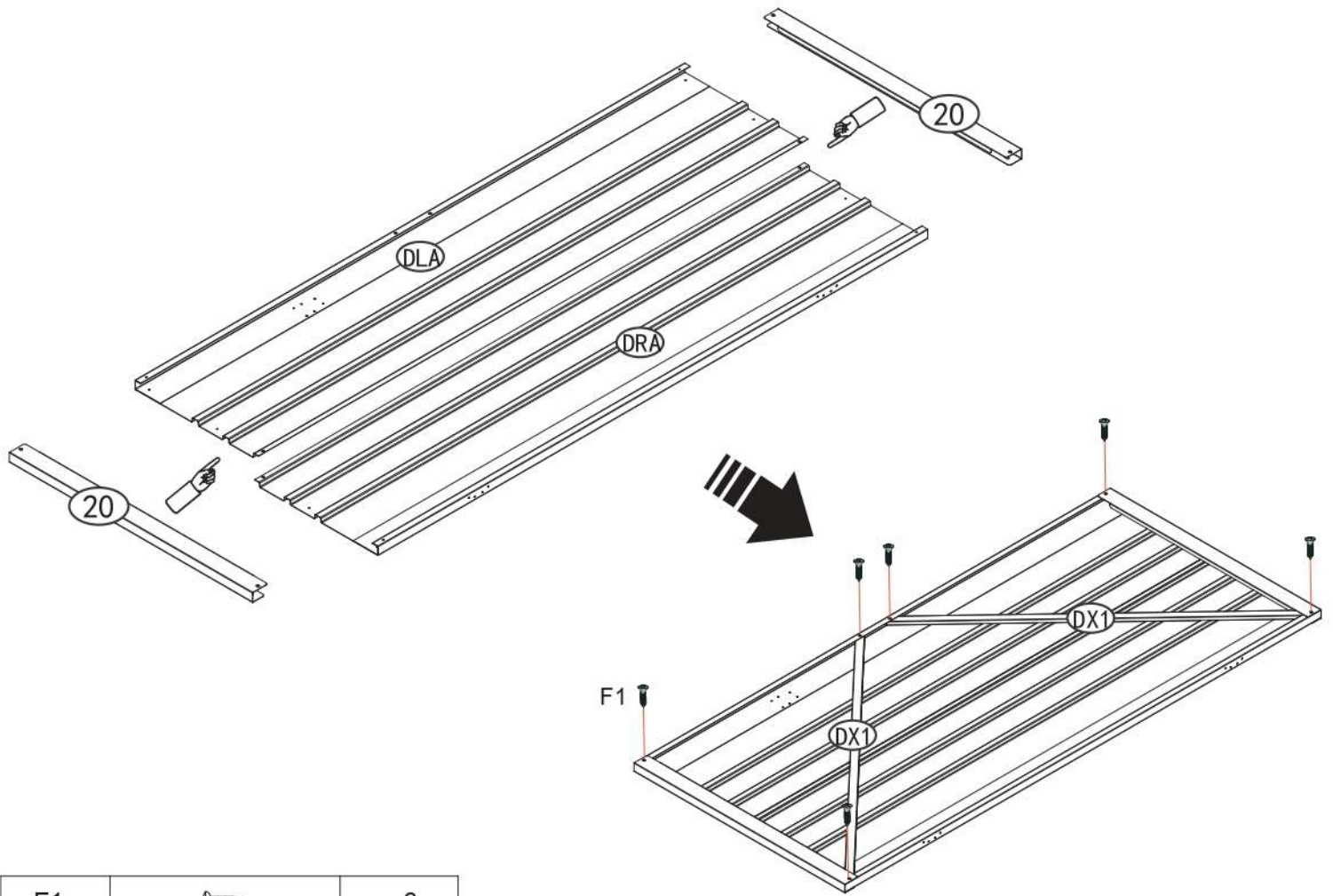

13		└	1
15		└	1
16		└	1
17		└	2
18		└	3
19		└	1
DC			1
F1			12
S2			7



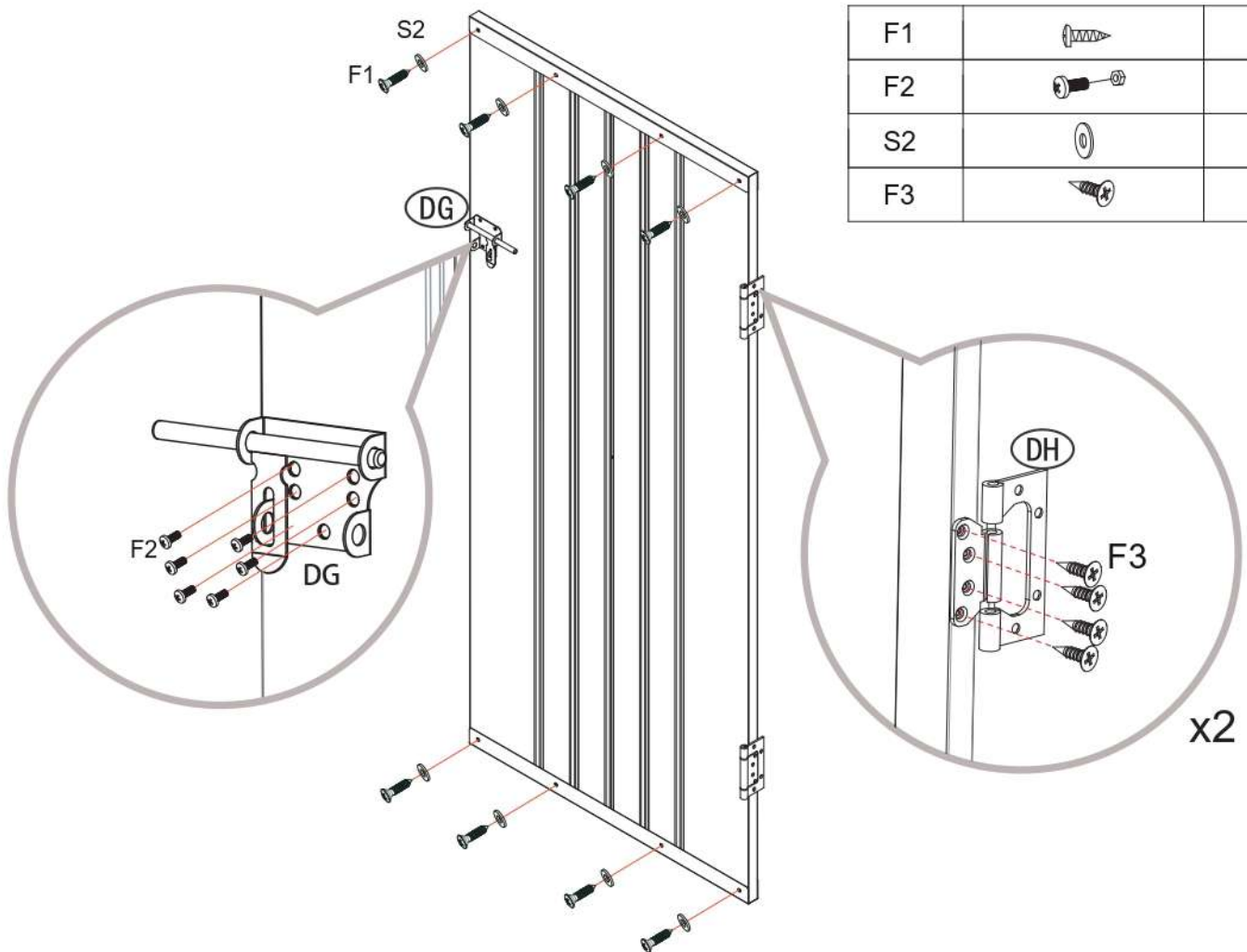



F1		6
----	---	---

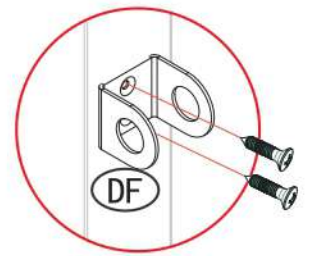

F1		8
F2		6
S2		8
F3		8



DF		1
F1		2

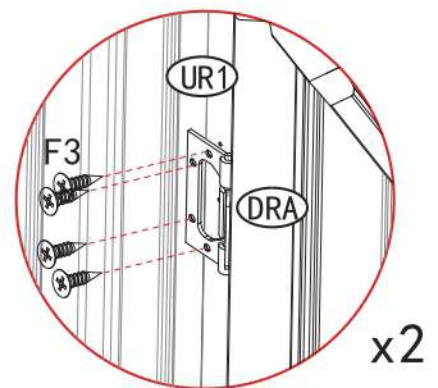
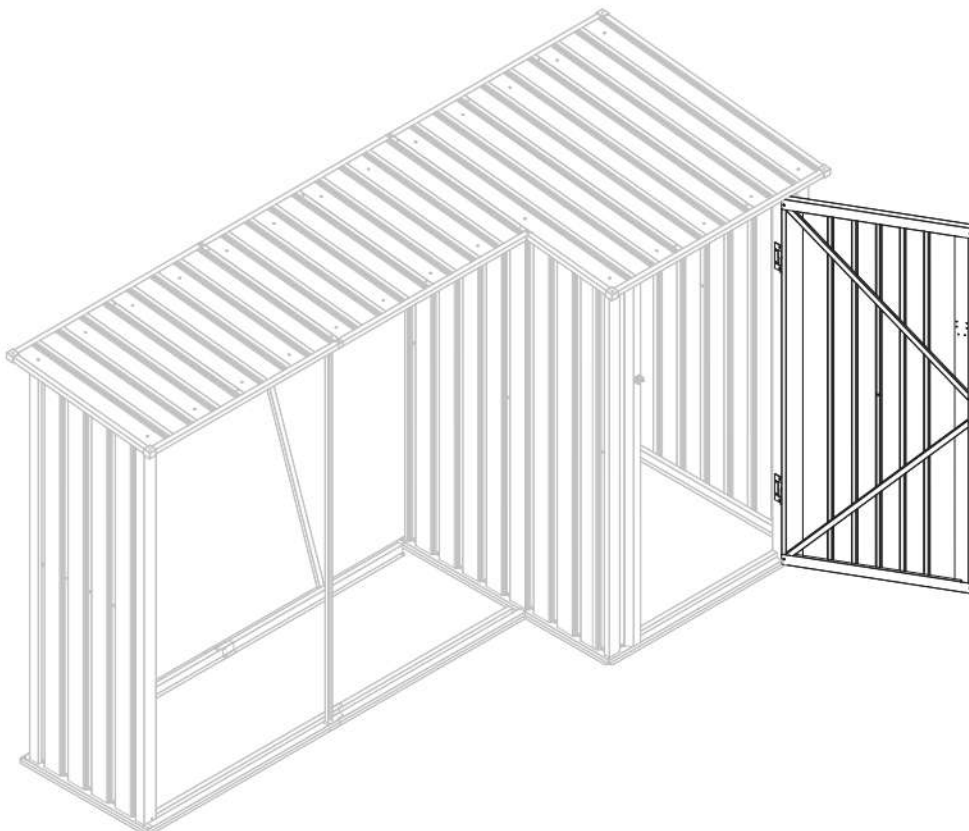

F3		8
----	---	---